

**30V, 190A, 2.5mΩ N-channel Power Trench MOSFET**
**JMTK018N03A**
**Features**

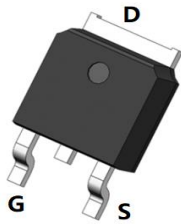
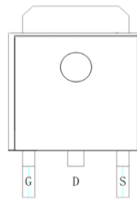
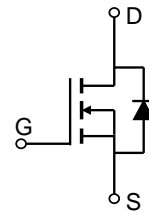
- Excellent  $R_{DS(ON)}$  and Low Gate Charge
- 100% UIS Tested
- 100%  $\Delta V_{ds}$  Tested
- Halogen-free; RoHS-compliant

**Applications**

- Load Switch
- PWM Application
- Power Management

**Product Summary**

Parameters	Value	Unit
$V_{DSS}$	30	V
$V_{GS(th\_Typ)}$	1.6	V
$I_D(@V_{GS}=10V)$	190	A
$R_{DS(ON\_Typ)}(@V_{GS}=10V)$	2.0	mΩ
$R_{DS(ON\_Typ)}(@V_{GS}=4.5V)$	2.5	mΩ


**TO-252-3L**

**Pin Assignment**

**Schematic Diagram**
**Ordering Information**

Device	Marking	MSL	Form	Package	Reel(pcs)	Per Carton (pcs)
JMTK018N03A	JMTK018N03A	3	Tape&Reel	TO-252-3L	2500	25000

**Absolute Maximum Ratings** (@  $T_C = 25^\circ\text{C}$  unless otherwise specified)

Symbol	Parameter	Value	Unit
$V_{DS}$	Drain-to-Source Voltage	30	V
$V_{GS}$	Gate-to-Source Voltage	$\pm 20$	V
$I_D$	Continuous Drain Current	$T_C = 25^\circ\text{C}$	190
		$T_C = 100^\circ\text{C}$	120
$I_{DM}$	Pulsed Drain Current <sup>(1)</sup>	Refer to Fig.4	A
$E_{AS}$	Single Pulsed Avalanche Energy <sup>(2)</sup>	271	mJ
$P_D$	Power Dissipation	$T_C = 25^\circ\text{C}$	50.0
		$T_C = 100^\circ\text{C}$	20.0
$T_J, T_{STG}$	Junction & Storage Temperature Range	-55 to 150	$^\circ\text{C}$

**Thermal Characteristics**

Symbol	Parameter	Max	Unit
$R_{\theta JA}$	Thermal Resistance, Junction to Ambient <sup>(3)</sup>	35	$^\circ\text{C/W}$
$R_{\theta JC}$	Thermal Resistance, Junction to Case	2.5	

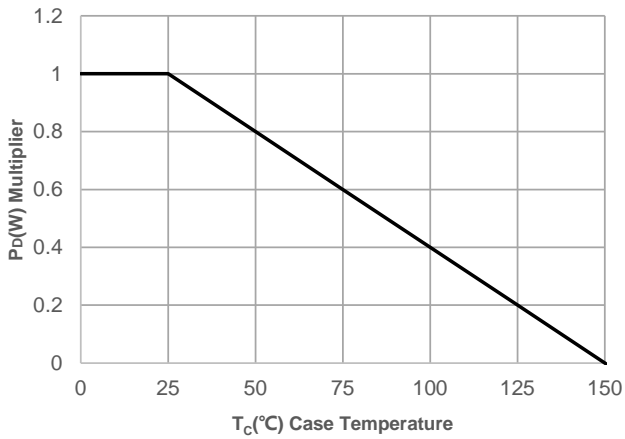
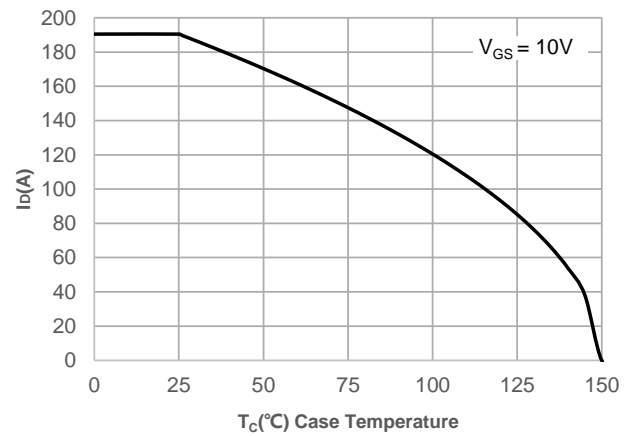
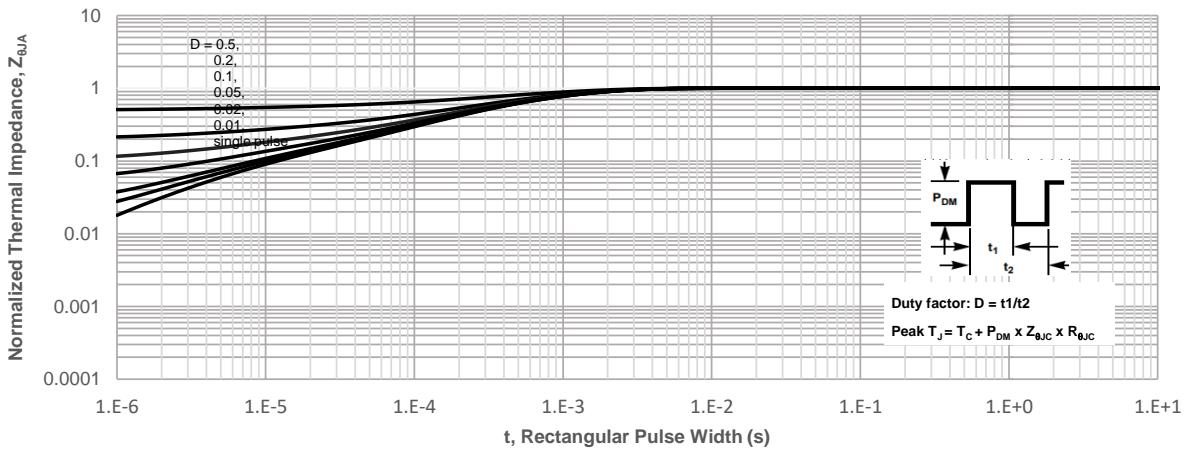
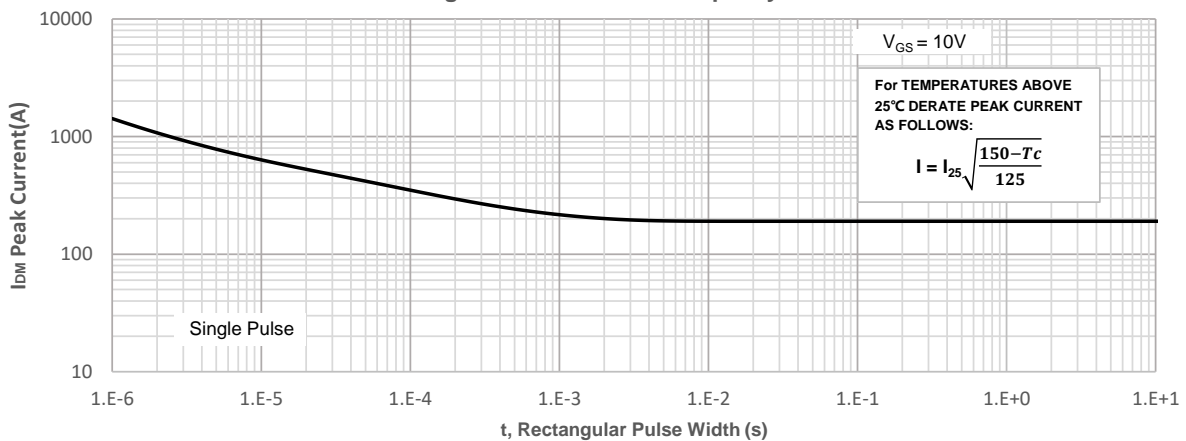
**Electrical Characteristics** ( $T_J = 25^\circ\text{C}$  unless otherwise specified)

Symbol	Parameter	Conditions	Min.	Typ.	Max.	Unit
<b>Off Characteristics</b>						
$V_{(BR)DSS}$	Drain-Source Breakdown Voltage	$I_D = 250\mu\text{A}$ , $V_{GS} = 0\text{V}$	30	-	-	V
$I_{DSS}$	Zero Gate Voltage Drain Current	$V_{DS} = 30\text{V}$ , $V_{GS} = 0\text{V}$	-	-	1.0	$\mu\text{A}$
$I_{GSS}$	Gate-Body Leakage Current	$V_{DS} = 0\text{V}$ , $V_{GS} = \pm 20\text{V}$	-	-	$\pm 100$	nA
<b>On Characteristics</b>						
$V_{GS(th)}$	Gate Threshold Voltage	$V_{DS} = V_{GS}$ , $I_D = 250\mu\text{A}$	1.1	1.6	2.5	V
$R_{DS(ON)}$	Static Drain-Source ON-Resistance <sup>(4)</sup>	$V_{GS} = 10\text{V}$ , $I_D = 20\text{A}$	-	2.0	2.6	$\text{m}\Omega$
		$V_{GS} = 4.5\text{V}$ , $I_D = 10\text{A}$	-	2.5	4.2	$\text{m}\Omega$
<b>Dynamic Characteristics</b>						
$R_g$	Gate Resistance	$f = 1\text{MHz}$	-	2.1	-	$\Omega$
$C_{iss}$	Input Capacitance	$V_{GS} = 0\text{V}$ , $V_{DS} = 15\text{V}$ , $f = 1\text{MHz}$	4484	6278	8475	pF
$C_{oss}$	Output Capacitance		616	863	1164	pF
$C_{rss}$	Reverse Transfer Capacitance		380	532	718	pF
$Q_g$	Total Gate Charge	$V_{GS} = 0$ to $10\text{V}$ $V_{DS} = 15\text{V}$ , $I_D = 30\text{A}$	77	108	146	nC
$Q_{gs}$	Gate Source Charge		14	20	27	nC
$Q_{gd}$	Gate Drain ("Miller") Charge		14	20	27	nC
<b>Switching Characteristics</b>						
$t_{d(on)}$	Turn-On Delay Time	$V_{GS} = 10\text{V}$ , $V_{DD} = 15\text{V}$ $I_D = 30\text{A}$ , $R_{GEN} = 3\Omega$	-	13	-	ns
$t_r$	Turn-On Rise Time		-	29	-	ns
$t_{d(off)}$	Turn-Off Delay Time		-	85	-	ns
$t_f$	Turn-Off Fall Time		-	50	-	ns
<b>Body Diode Characteristics</b>						
$I_S$	Maximum Continuous Body Diode Forward Current		-	-	190	A
$I_{SM}$	Maximum Pulsed Body Diode Forward Current		-	-	762	A
$V_{SD}$	Body Diode Forward Voltage	$V_{GS} = 0\text{V}$ , $I_S = 20\text{A}$	-		1.2	V
$t_{rr}$	Body Diode Reverse Recovery Time	$I_F = 20\text{A}$ , $di/dt = 100\text{A}/\mu\text{s}$	20	28	38	ns
$Q_{rr}$	Body Diode Reverse Recovery Charge		-	16.0	-	nC

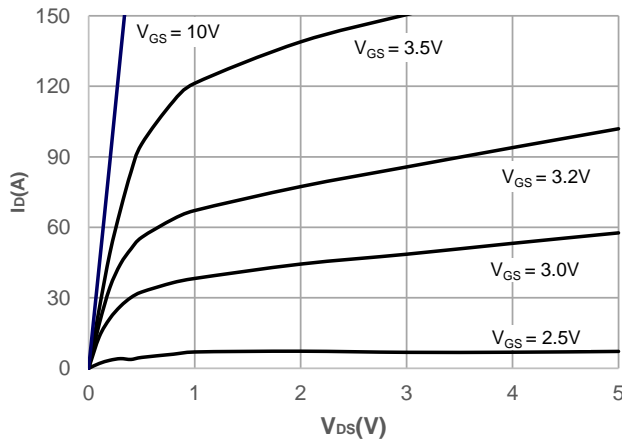
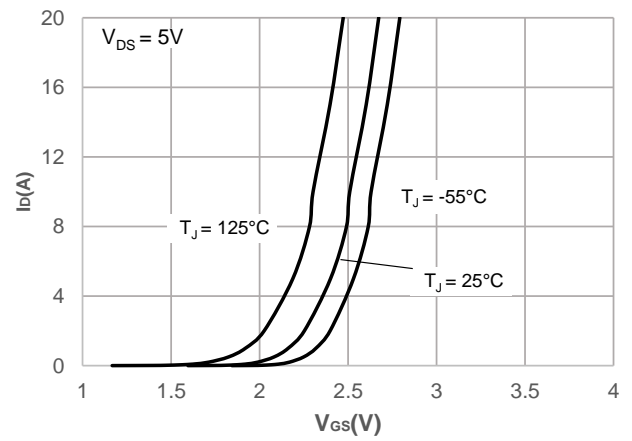
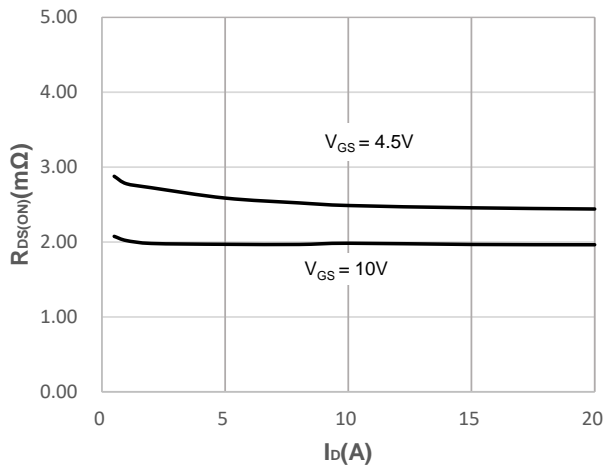
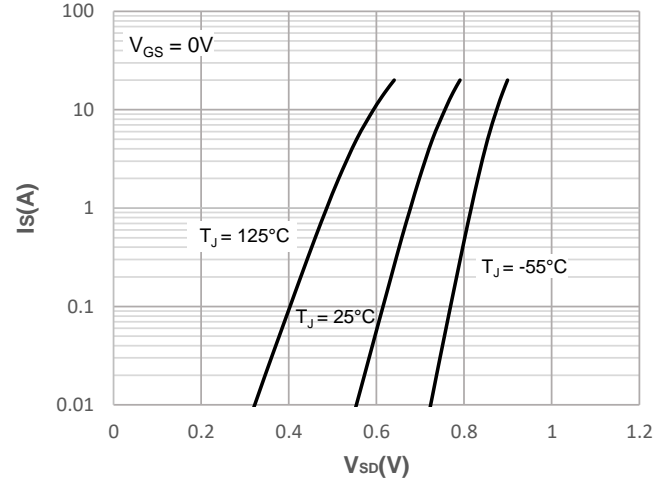
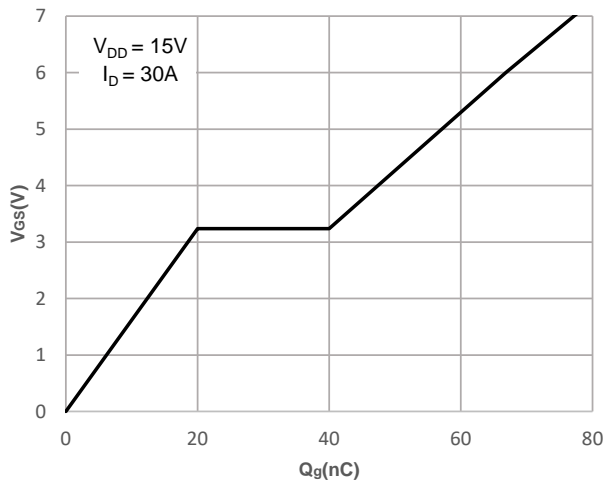
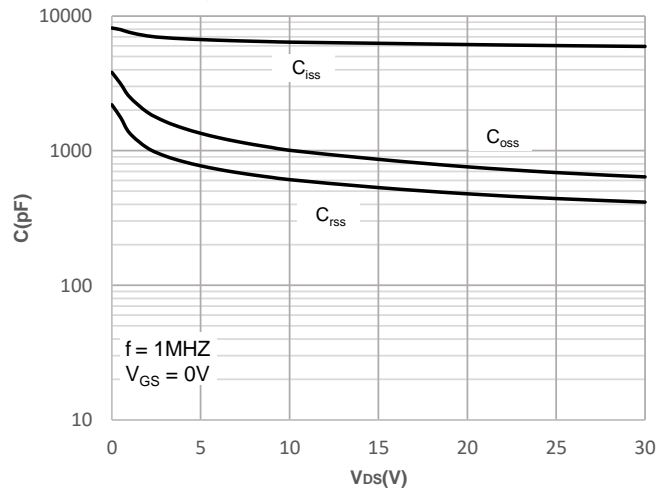
- Notes:
1. Repetitive Rating: Pulse Width Limited by Maximum Junction Temperature.
  2.  $E_{AS}$  condition: Starting  $T_J = 25^\circ\text{C}$ ,  $V_{DD} = 15\text{V}$ ,  $V_G = 10\text{V}$ ,  $R_G = 25\text{ohm}$ ,  $L = 0.5\text{mH}$ ,  $I_{AS} = 33.04\text{A}$ ,  $V_{DD} = 0\text{V}$  during time in avalanche.
  3.  $R_{\theta JA}$  is measured with the device mounted on a  $1\text{inch}^2$  pad of 2oz copper FR4 PCB.
  4. Pulse Test: Pulse Width  $\leq 300\mu\text{s}$ , Duty Cycle  $\leq 0.5\%$ .



## Typical Performance Characteristics

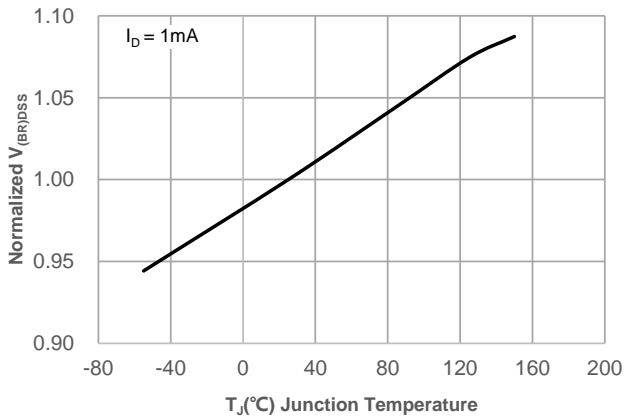
**Figure 1: Power De-rating**

**Figure 2: Current De-rating**

**Figure 3: Normalized Maximum Transient Thermal Impedance**

**Figure 4: Peak Current Capacity**


## Typical Performance Characteristics

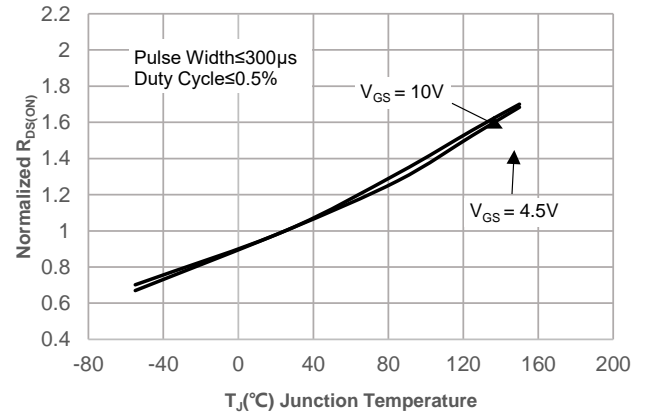
**Figure 5: Output Characteristics**

**Figure 6: Typical Transfer Characteristics**

**Figure 7: On-resistance vs. Drain Current**

**Figure 8: Body Diode Characteristics**

**Figure 9: Gate Charge Characteristics**

**Figure 10: Capacitance Characteristics**


## Typical Performance Characteristics

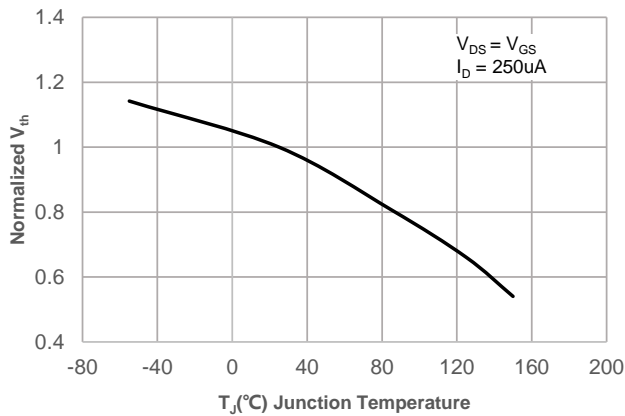
**Figure 11: Normalized Breakdown voltage vs. Junction Temperature**



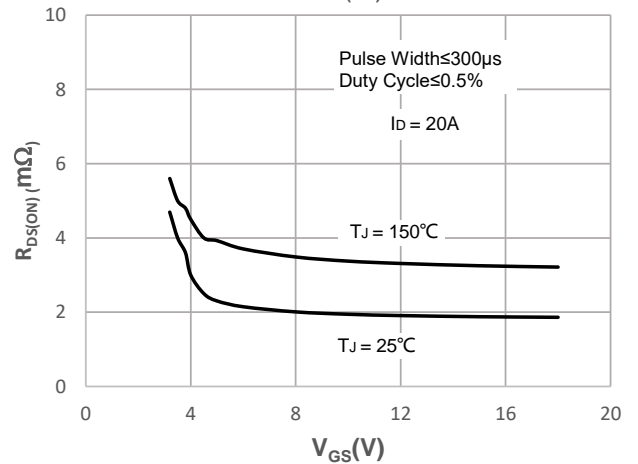
**Figure 12: Normalized on Resistance vs. Junction Temperature**



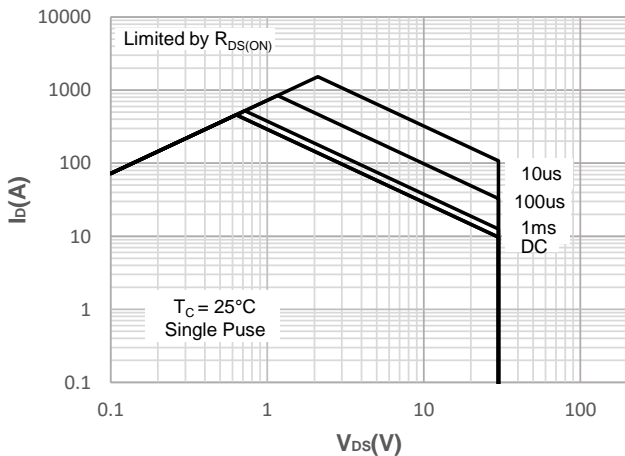
**Figure 13: Normalized Threshold Voltage vs. Junction Temperature**

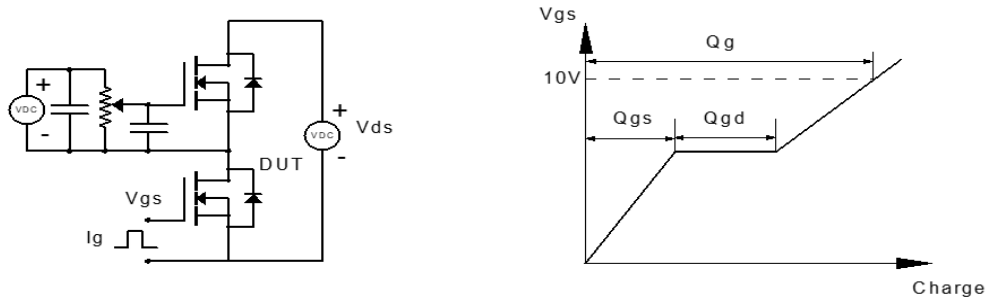
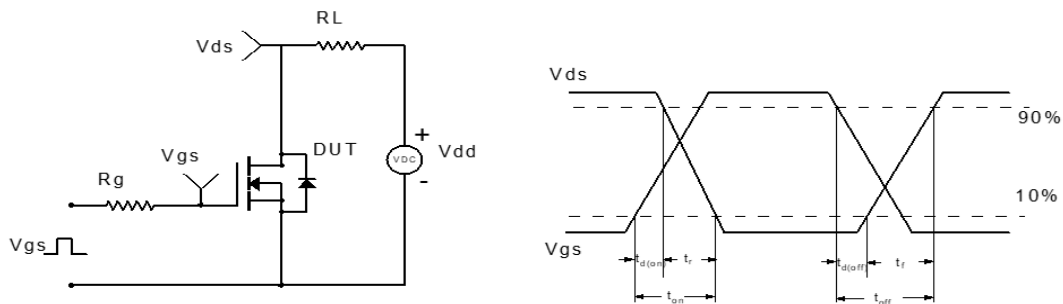
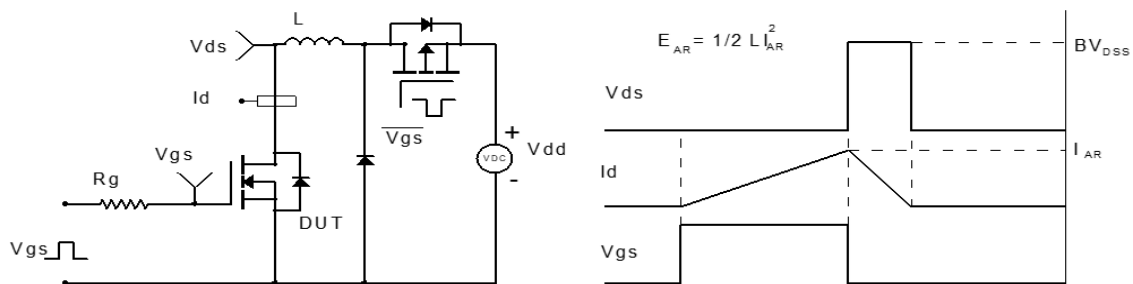
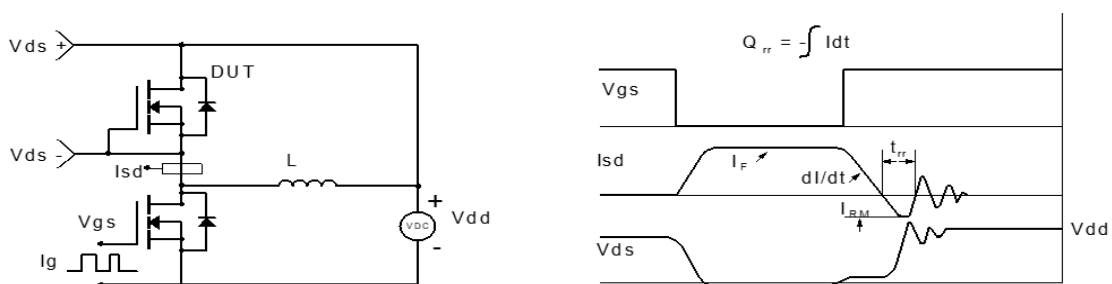


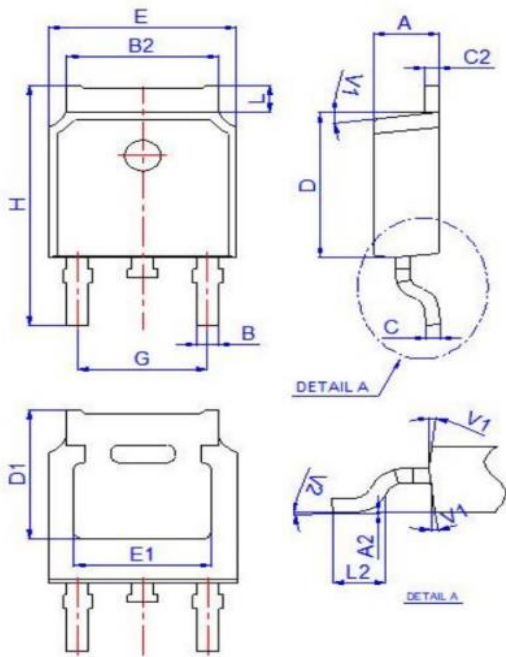
**Figure 14:  $R_{DS(ON)}$  vs.  $V_{GS}$**



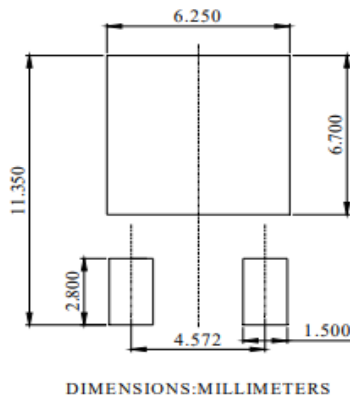
**Figure 15: Maximum Safe Operating Area**



**Test Circuit**

**Figure 1: Gate Charge Test Circuit & Waveform**

**Figure 2: Resistive Switching Test Circuit & Waveform**

**Figure 3: Unclamped Inductive Switching Test Circuit & Waveform**

**Figure 4: Diode Recovery Test Circuit & Waveform**

**Package Mechanical Data(TO-252-3L)**


Ref.	Dimensions					
	Millimeters			Inches		
	Min.	Typ.	Max.	Min.	Typ.	Max.
A	2.10		2.50	0.083		0.098
A2	0		0.10	0		0.004
B	0.66		0.86	0.026		0.034
B2	5.18		5.48	0.202		0.216
C	0.40		0.60	0.016		0.024
C2	0.44		0.58	0.017		0.023
D	5.90		6.30	0.232		0.248
D1	5.30REF			0.209REF		
E	6.40		6.80	0.252		0.268
E1	4.63			0.182		
G	4.47		4.67	0.176		0.184
H	9.50		10.70	0.374		0.421
L	1.09		1.21	0.043		0.048
L2	1.35		1.65	0.053		0.065
V1		7°			7°	
V2	0°		6°	0°		6°

**Recommended Soldering Footprint**


Information furnished in this document is believed to be accurate and reliable. However, Jianguo JieJie Microelectronics Co.,Ltd assumes no responsibility for the consequences of use without consideration for such information nor use beyond it. Information mentioned in this document is subject to change without notice, apart from that when an agreement is signed, Jianguo JieJie complies with the agreement. Products and information provided in this document have no infringement of patents. Jianguo JieJie assumes no responsibility for any infringement of other rights of third parties which may result from the use of such products and information.



is a registered trademark of Jianguo JieJie Microelectronics Co.,Ltd.

